

Oil Seals for Rotating Shafts.....2
Technical Data.....3
Technical Data (continued).....4
Technical Data (continued).....5

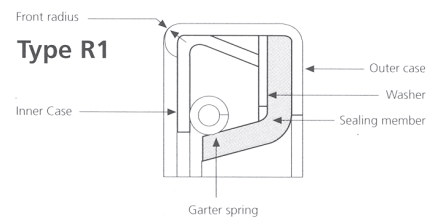

Imperial and metric sizes. Non standard sizes made to order.

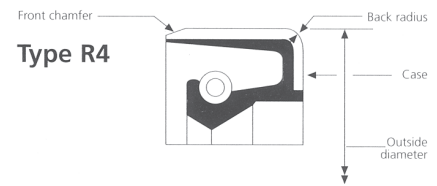
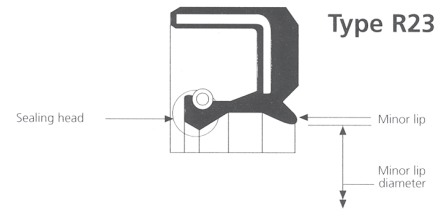
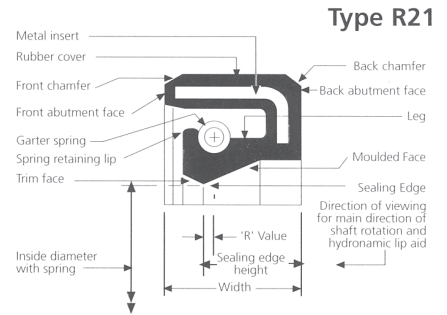

Satisfactory performance of a rotary shaft lip seal depends on a large number of factors. Some are governed by seal design and manufacture, and the material used, and others by application conditions. It is important to understand the basic influence of these factors in order to maximise seal performance.

LUBRICATION

A rotary shaft lip seal of modern design requires adequate lubrication by the sealed fluid to provide optimum life. When properly lubricated and under dynamic conditions a thin film of fluid approximately .002mm thick is generated between the sealing lip and the shaft, once the seal is bedded-in. Bedding-in during the first few minutes of operation modifies the nominally sharp edge of the seal to a flat by abrasion. Statically the lubricant film virtually disappears and rubber to metal contact is re-established. Not only does the fluid lubricate the seal, but it cools the sealing lip. The effect of dry running, either by starvation of lubricant or by using a seal having too high a radial load, is to prolong the time during which rubber to metal contact occurs, resulting in wear of the seal, and to increase the lip temperature. Should the lip temperature exceed the capability of the rubber, the seal lip will harden and eventually crack. Restoration of lubrication after such an occurrence results in leakage.

The maintenance of a stable fluid film under the lip without leakage occurring, depends partly on the characteristics of the sealed fluid, for example, the viscosity and surface tension, and partly on the ability of the sealing lip to follow the shaft surface. This latter ability depends upon a complex relationship between the radial load, the resilience of the rubber, and the geometry and surface topography of the shaft surface. The resilience of the rubber depends on the compound formulation and its operating temperature. Heat generated at the sealing lip also affects the fluid viscosity, so that satisfactory lubrication and sealing depends on the complex interaction of several factors. It must be stated that a leather seal operates somewhat differently since the band of contact between the leather and the shaft is much broader, and the leather is lubricated by some absorption of the sealed fluid.

SHAFT ECCENTRICITY

Dynamic shaft eccentricity or shaft whip should be kept at a minimum to avoid the sealing lip failing to follow the shaft at high speed. Ideally, the seal should be positioned adjacent to a bearing and attention given to good dynamic balance. No absolute figure can be stated since the higher the shaft eccentricity, the greater

will be the problems. However, using a standard seal the shaft eccentricity should never exceed 0.3mm T.I.R.

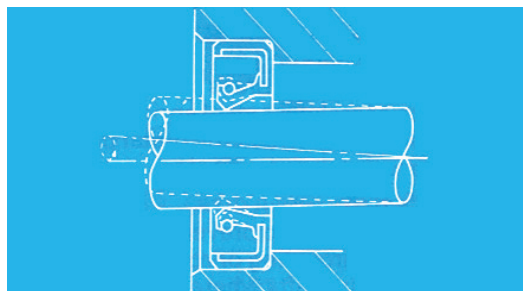

HOUSING OFFSET

This is similar to but not as severe in its effects as shaft eccentricity. The radial load of the seal is made to vary around its periphery, resulting in uneven bedding-in and wear, and the lip interference at one position may be insufficient to effect a seal. It also has the same effect as skewing a seal, producing unreliable performance.

Under no circumstances should the housing offset exceed 0.25mm.

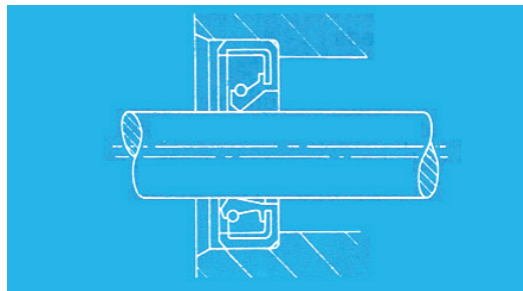

SHAFT OSCILLATION

Certain applications where total dynamic balancing cannot be achieved produce bending and torsional oscillations. In conditions where these are relatively severe for example in a crankshaft, standard seals will give only limited performance.

SHAFT AXIAL MOVEMENT

A standard seal will provide adequate performance where a small amount of axial movement is experienced. Where the shaft is designed to have a significant axial movement a special seal design may be required.

PRESSURE

The effect of pressure in the sealed system is twofold. Firstly, it increases the pressure within the fluid film under the sealing edge tending to produce leakage. Secondly, it acts on the sealing lip tending to force it into closer contact with the shaft, increasing the frictional heat.

Under favourable circumstances, standard seals can be used up to pressures of 70 KN/m² but other factors such as high speed or shaft

eccentricity may limit this to 35 KN/m².

Note that fluctuating pressure, particularly at high frequency is a more difficult condition to satisfy than a steady pressure.

TEMPERATURE

The temperature limits within which a seal can operate are primarily dictated by the polymer. Pioneer Weston seals in standard material can tolerate a range of temperature between -30°C and +120°C. This must take into account not only the ambient temperature of the fluid being sealed, but also the generated under lip temperature. At high speed the under lip temperature can be as high as 40°C in excess of the ambient temperature.

At low temperature rubber becomes brittle and can fracture when stressed. Therefore, the practical limit to which rotary shaft lip seals can be used is that which does not cause fracture due to start-up torque and shaft eccentricity effects. It is related to, but not identical to the brittle point of the material. Pioneer Weston rubber seals can be used down to -30°C and leather seals down to -40°C.

SPEED

It will be seen that the maximum speed up to which standard seals may be used is limited primarily by the temperature generated by

frictional heat. Seals manufactured in more heat resistant materials such as acrylic or silicone rubber permit an increase in maximum speed. Pioneer Weston standard rubber seals can be used up to a surface speed of 12 to 15 metres/sec. and leather seals up to 10 metres/sec.

The graph below gives general guidance as to the limits of shaft speeds for nitrile, acrylic, silicone and fluorocarbon rubber.

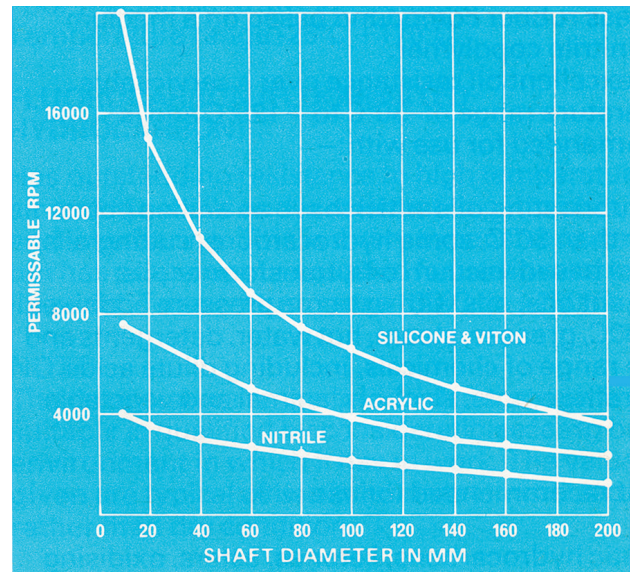

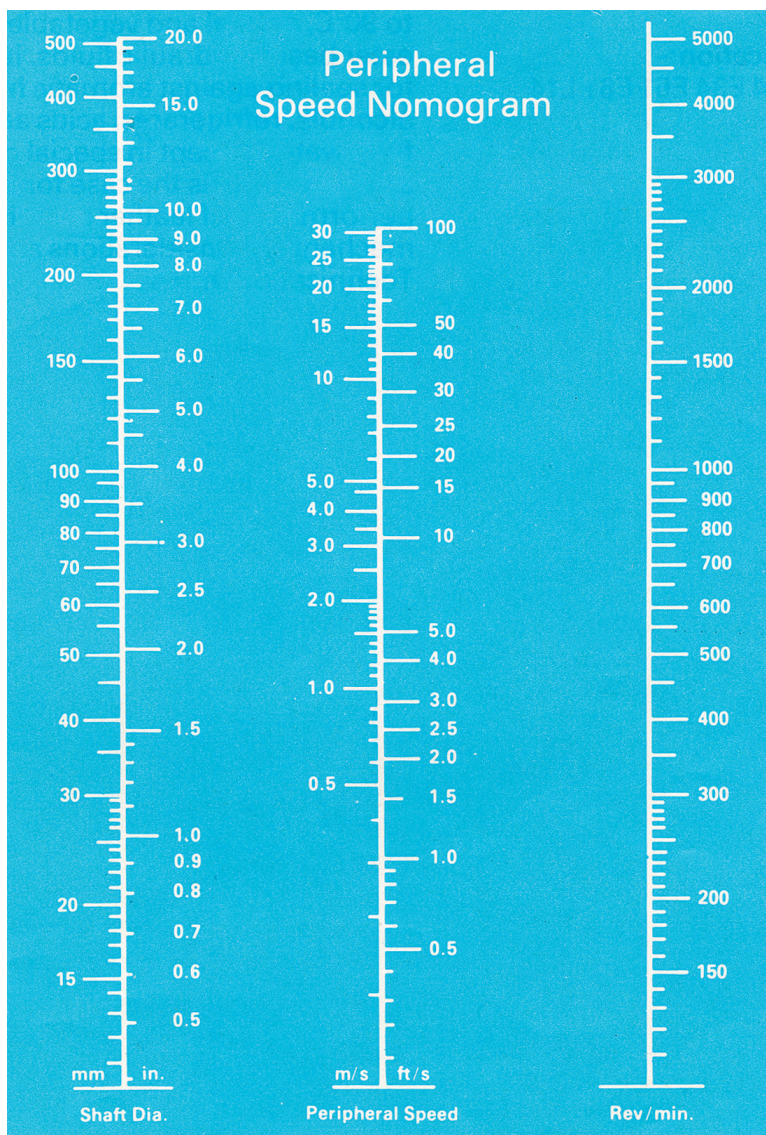

To obtain peripheral speed, place straight edge across nomogram connecting shaft dia. scale with rev/min scale and read figure on centre scale.